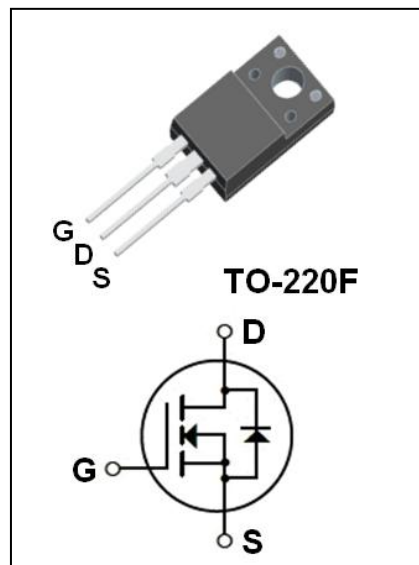

**●Features:**

- 7.0A, 700V,  $R_{DS(on)(Typ)} = 1.2\Omega @ V_{GS}=10V$
- Low Gate Charge
- Low  $C_{rss}$
- 100% Avalanche Tested
- Fast Switching
- Improved dv/dt Capability

**●Application:**

- High Frequency Switching Mode Power Supply
- Active Power Factor Correction

**Absolute Maximum Ratings**( $T_C=25^\circ\text{C}$  unless otherwise noted)

Symbol	Parameter	Value	Unit
$V_{DSS}$	Drain-Source Voltage	700	V
$I_D$	Drain Current - Continuous( $T_C=25^\circ\text{C}$ ) - Continuous( $T_C=100^\circ\text{C}$ )	7.0*	A
		4.5*	A
$I_{DM}$	Drain Current -Pulsed (Note1)	28*	A
$V_{GSS}$	Gate-Source Voltage	$\pm 30$	V
$E_{AS}$	Single Pulsed Avalanche Energy (Note2)	590	mJ
$I_{AR}$	Avalanche Current (Note1)	7.0	A
$E_{AR}$	Repetitive Avalanche Energy (Note1)	14.0	mJ
dv/dt	Peak Diode Recovery dv/dt (Note3)	4.5	V/ns
$P_D$	Power Dissipation( $T_C =25^\circ\text{C}$ ) -Derate above $25^\circ\text{C}$	48	W
		0.38	W/ $^\circ\text{C}$
$T_j$	Operating Junction Temperature	150	$^\circ\text{C}$
$T_{stg}$	Storage Temperature Range	-55 to+150	$^\circ\text{C}$

\* Drain Current Limited by Maximum Junction Temperature.

**Thermal Characteristics**

Symbol	Parameter	Max	Unit
$R_{\theta JC}$	Thermal Resistance,Junction to Case	2.6	$^\circ\text{C} / \text{W}$
$R_{\theta JA}$	Thermal Resistance,Junction to Ambient	62.5	$^\circ\text{C} / \text{W}$

**Electrical Characteristics**(Tc=25°C unless otherwise noted)

Symbol	Parameter	Test Conditions	Min	Typ	Max	Unit
<b>Off Characteristics</b>						
BV <sub>DSS</sub>	Drain-source Breakdown Voltage	V <sub>GS</sub> =0V, I <sub>D</sub> =250μA	700	--	--	V
ΔBV <sub>DSS</sub> /ΔT <sub>J</sub>	Breakdown Voltage Temperature Coefficient	I <sub>D</sub> =250μA (Referenced to 25°C)	--	0.7	--	V/°C
I <sub>DSS</sub>	Zero Gate Voltage Drain Current	V <sub>DS</sub> =700V, V <sub>GS</sub> =0V	--	--	1	μA
		V <sub>DS</sub> =560V, Tc=125°C	--	--	10	μA
I <sub>GSSF</sub>	Gate-Body Leakage Current, Forward	V <sub>GS</sub> =+30V, V <sub>DS</sub> =0V	--	--	100	nA
I <sub>GSSR</sub>	Gate-Body Leakage Current, Reverse	V <sub>GS</sub> =-30V, V <sub>DS</sub> =0V	--	--	-100	nA
<b>On Characteristics</b>						
V <sub>GS(th)</sub>	Gate Threshold Voltage	V <sub>DS</sub> = V <sub>GS</sub> , I <sub>D</sub> =250μA	2.0	--	4.0	V
R <sub>DSON</sub>	Static Drain-Source On-Resistance	V <sub>GS</sub> =10 V, I <sub>D</sub> =3.5A	--	1.2	1.4	Ω
g <sub>FS</sub>	Forward Transconductance	V <sub>DS</sub> =40 V, I <sub>D</sub> =3.5A (Note4)	--	6.5	--	S
<b>Dynamic Characteristics</b>						
C <sub>iss</sub>	Input Capacitance	V <sub>DS</sub> =25V, V <sub>GS</sub> =0V, f=1.0MHz	--	1380	--	pF
C <sub>oss</sub>	Output Capacitance		--	170	--	pF
C <sub>rss</sub>	Reverse Transfer Capacitance		--	15	--	pF
<b>Switching Characteristics</b>						
t <sub>d(on)</sub>	Turn-On Delay Time	V <sub>DD</sub> = 350 V, I <sub>D</sub> = 7.0 A, R <sub>G</sub> = 25 Ω (Note4,5)	--	13	--	ns
t <sub>r</sub>	Turn-On Rise Time		--	100	--	ns
t <sub>d(off)</sub>	Turn-Off Delay Time		--	126	--	ns
t <sub>f</sub>	Turn-Off Fall Time		--	48	--	ns
Q <sub>g</sub>	Total Gate Charge	V <sub>DS</sub> = 560 V, I <sub>D</sub> = 7.0 A, V <sub>GS</sub> = 10 V (Note4,5)	--	30	--	nC
Q <sub>gs</sub>	Gate-Source Charge		--	6	--	nC
Q <sub>gd</sub>	Gate-Drain Charge		--	14	--	nC
<b>Drain-Source Diode Characteristics and Maximum Ratings</b>						
I <sub>S</sub>	Maximum Continuous Drain-Source Diode Forward Current		--	--	7.0	A
I <sub>SM</sub>	Maximum Pulsed Drain-Source Diode Forward Current		--	--	28	A
V <sub>SD</sub>	Drain-Source Diode Forward Voltage	V <sub>GS</sub> =0V, I <sub>S</sub> =7.0A	--	--	1.4	V
t <sub>rr</sub>	Reverse Recovery Time	V <sub>GS</sub> =0V, I <sub>S</sub> =7.0A, d I <sub>F</sub> /dt=100A/μs (Note4)	--	315	--	ns
Q <sub>rr</sub>	Reverse Recovery Charge		--	2.6	--	μC

**Notes:**

- 1、Repetitive Rating:Pulse Width Limited by Maximum Junction Temperature.
- 2、L = 19.5mH, I<sub>AS</sub> =7.0A, V<sub>DD</sub> = 50V, R<sub>G</sub> = 25 Ω, Starting T<sub>J</sub> = 25°C.
- 3、I<sub>SD</sub>≤7.0A, di/dt≤200A/μs, V<sub>DD</sub>≤BV<sub>DSS</sub>, Starting T<sub>J</sub> = 25°C.
- 4、Pulse Test : Pulse Width ≤300 μ s, Duty Cycle≤2%.
- 5、Essentially Independent of Operating Temperature.

**On-Regin Characteristics**

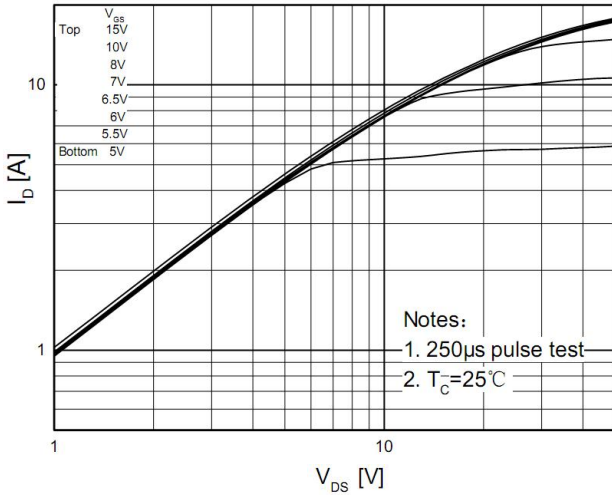

**Transfer Characteristics**

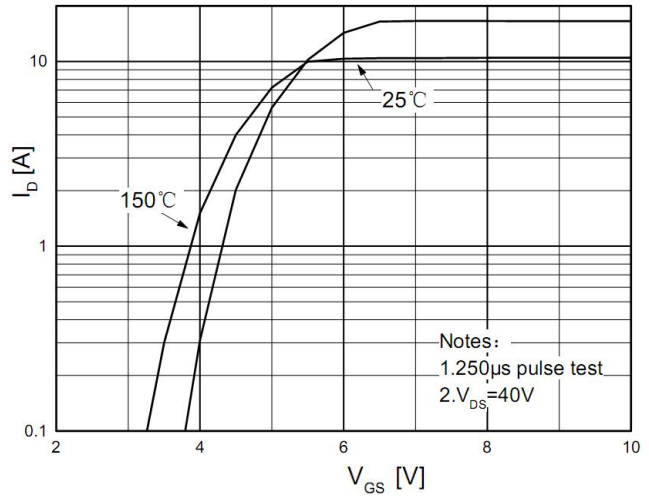

**On-Resistance Variation vs. Drain Current and Gate Voltage**

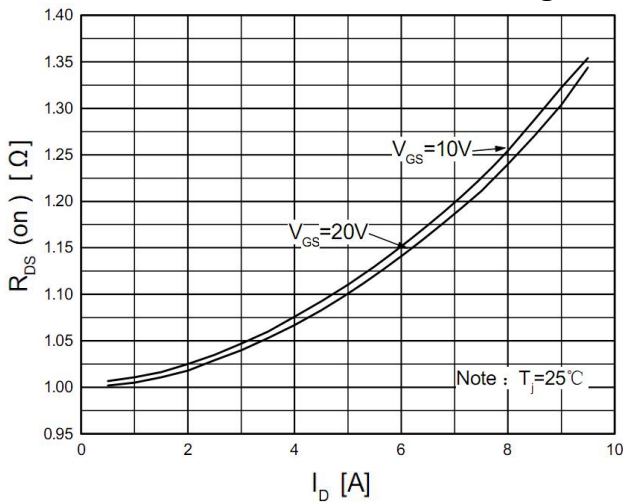

**Body Diode Forward Voltage Variation vs. Source Current and Temperature**

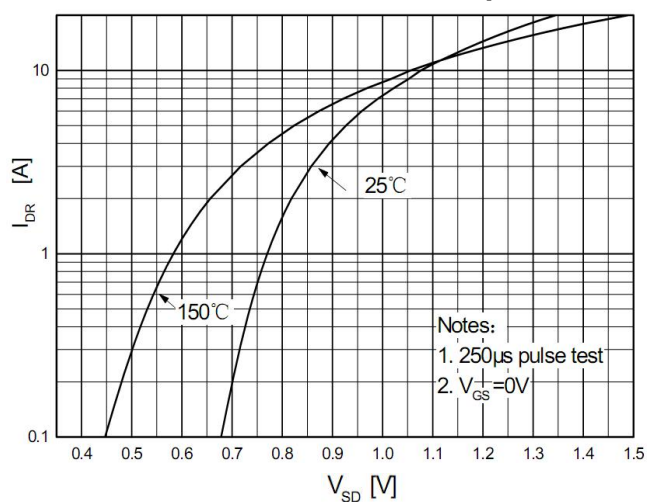

**Capacitance Characteristics**

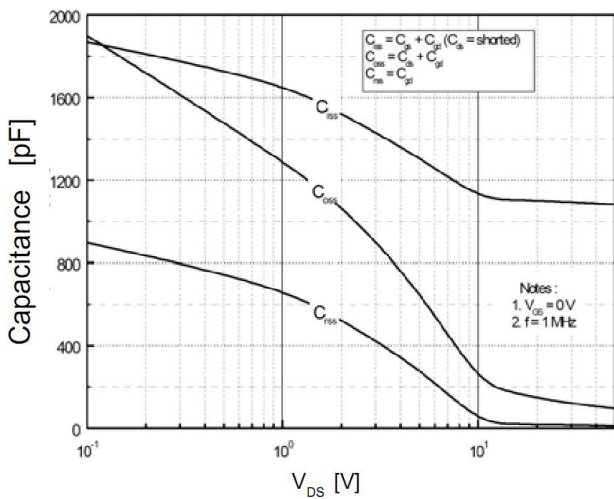

**Gate Charge Characteristics**

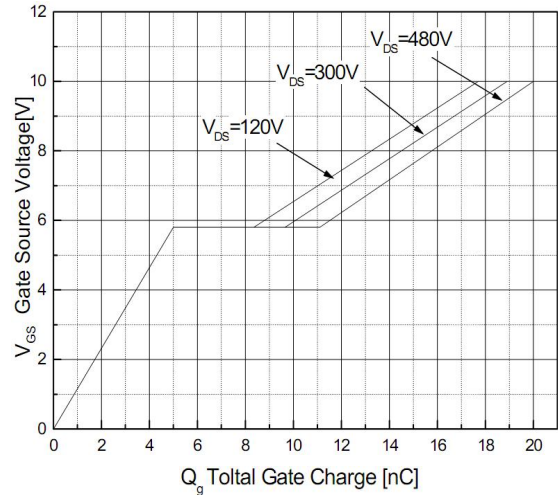

**Breakdown Voltage Variation vs. Temperature**

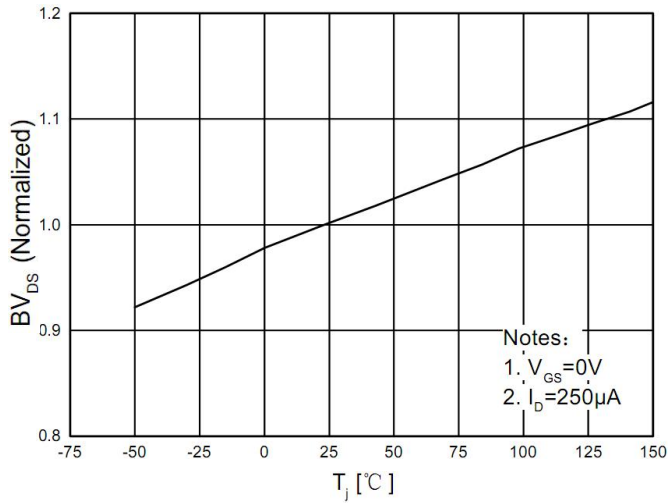

**On-Resistance Variation vs. Temperature**

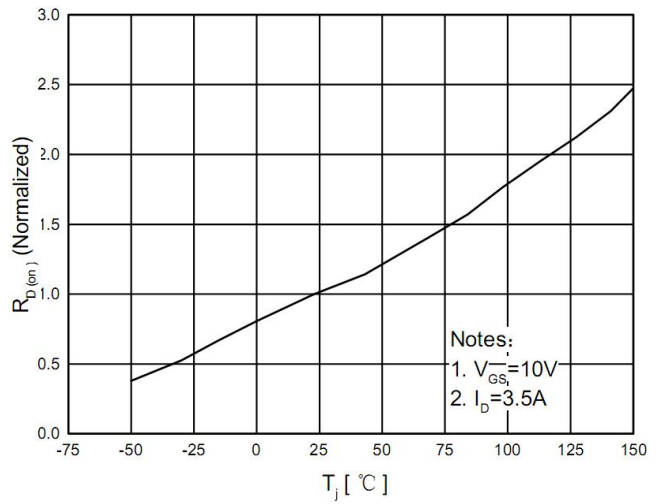

**Maximum Safe Operating Area**

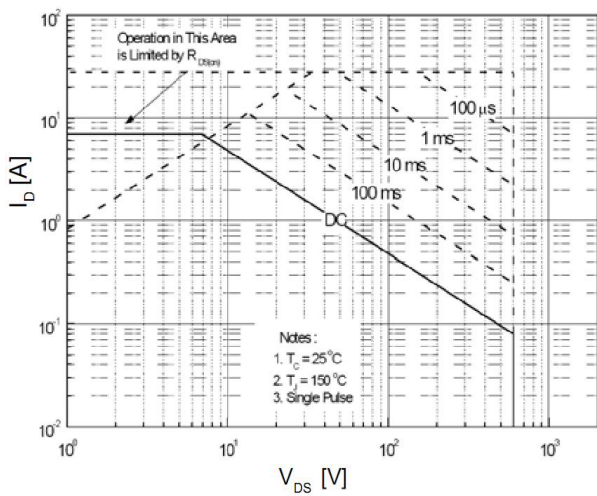

**Maximum Drain Current Vs. Case Temperature**

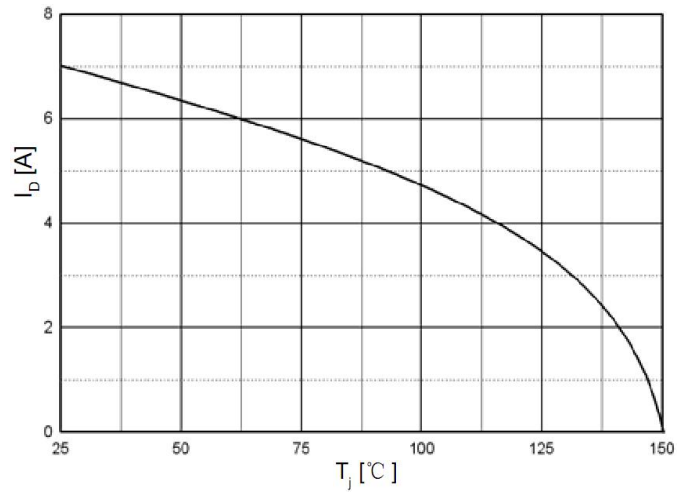

### TO-220F Package Dimensions

UNIT: mm

SYMBOL	min	nom	max	SYMBOL	min	nom	max
A	9.80		10.60	D		2.54	
A1		7.00		D1	1.15		1.55
A2	2.90		3.40	D2	0.60		1.00
A3	9.10		9.90	D3	0.20		0.50
B1	15.40		16.40	E	2.24		2.84
B2	4.35		4.95	E1		0.70	
B3	6.00		7.40	E2		1.0×45°	
C	3.00		3.70	E3	0.35		0.65
C1	15.00		17.00	E4	2.30		3.30
C2	8.80		10.80	α (度)		30°	

