



ORIENT

Photo coupler

Product Data Sheet

Name: OR-M6XX

Customer: _____

Date: _____

一级代理商：

深圳市弗瑞鑫电子有限公司

地址：深圳市宝安区西乡大道302号金源商务大厦B座三楼

TEL: 0755-29563634

FAX: 0755-27447020

www.frxelec.com

1. Features

- (1) Compliance Halogens Free (Br < 900ppm, Cl < 900ppm, Br+Cl <1500ppm)
- (2) 3.3V / 5V supply voltage
- (3) low power consumption
- (4) high speed: 10MBd(typical)
- (5) VCM=1000V, and the lowest common mode inhibition (CMR) is 10 kV/μs
- (6) when - 40 °C ~ + 125 °C temperature of ac and dc performance
- (7) Safety approval
 - UL approved(No.E323844)
 - VDE approved(No.40029733)
 - CQC approved (No.CQC19001231256)
- (8) In compliance with RoHS, REACH standards
- (9) MSL Class I



2. Instructions

OR-M6XX is made up of an efficient AlGaAs light-emitting diode and high-speed optical detector. This design provides good ac and dc isolation between the input and output ends of the photoelectric coupler. The output characteristic of the photodetector is a collector open circuit schottky clamp transistor. The photoelectric coupler operating temperature range: - 40 °C ~ + 125 °C.

3. Application Range

- (1)Ground loop elimination
- (2)LSTTL to TTL, LSTTL or 5 volt CMOS
- (3)Line receiver, data transmission
- (4)Data multiplexing
- (5)Switching power supplies
- (6)Pulse transformer replacement
- (7)Computer peripheral interface

4. Functional Diagram

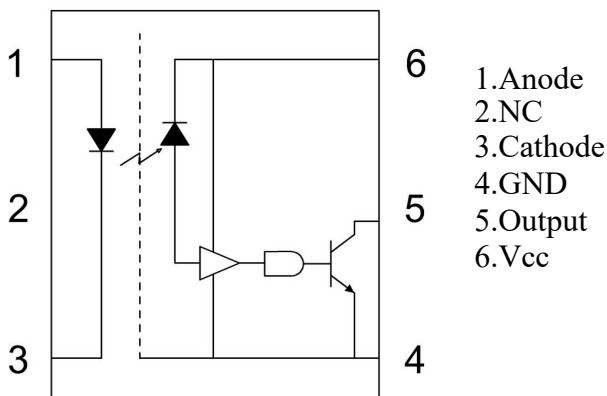

Truth table

Input (LED)	Output
ON	L
OFF	H

0.1 capacitor F bypass capacitance needs to be connected between A Pin4 and Pin6

5. Absolute Maximum Ratings (Ta=25°C)*1

Parameter		Symbol	Rated Value	Unit
Input	Average Forward Input Current	I _F	50	mA
	Reverse Input Voltage	V _R	5	V
	Power Dissipation	P _I	40	mW
Output	Output Collector Current	I _O	50	mA
	Output Collector Voltage	V _O	7	V
	Output Collector Power Dissipation	P _O	85	mW
Supply Voltage		V _{CC}	7	V
Insulation Voltage		V _{iso}	3750	V _{rms}
Working Temperature		T _{opr}	-40 ~ +125	°C
Storage Temperature		T _{stg}	-55 ~ +150	
*2	Soldering Temperature	T _{sol}	260	

*1. Room temperature = 25 °C. Exceeding the maximum absolute rating can permanently damage the device. Working long hours at the maximum absolute rating can affect reliability.

*2. soldering time is 10 seconds.

6. Recommended Operating Conditions

Parameter	Symbol	Min	Max	Unit
Operating Temperature	T _A	-40	125	°C
Supply Voltage	V _{CC}	2.7	3.6	V
		4.5	5.5	
Low Level Input Current	I _{FL}	0	250	μA
High Level Input Current	I _{FH}	5	15	mA
Output Pull-up Resistor	R _L	330	4000	Ω
Fan Out (at R _L =1kΩ per channel)	N	—	5	TTL Loads

7. Opto-Electronic Characteristics

	Parameter	Symbol	Min	Typ	Max	Unit	Condition
Input	Forward Voltage	V_F	—	1.38	1.8	V	$I_F = 10\text{mA}$ $T_A = 25^\circ\text{C}$
	Temperature Coefficient OF Forward Voltage	$\Delta V_F / \Delta T$	—	-1.6	—	mV/°C	$I_F = 10\text{mA}$
	Reverse Voltage	BV_R	5	—	—	V	$I_R = 10\mu\text{A}$
	Input Threshold Current	I_{TH}	—	1.5	5	mA	$V_E = 2\text{V}, V_{CC} = 3.3\text{V}$ $V_O = 0.6\text{V}$ $I_{OL} (\text{sinking}) = 13\text{mA}$
	Input Capacitance	C_{IN}	—	34	—	pF	$f = 1\text{MHz}, V_F = 0\text{V}$
Detector	High Level Supply Current	I_{CCH}	—	3.8	7	mA	$V_{CC} = 3.3\text{V}, I_F = 0\text{mA}$
	Low Level Supply Current	I_{CCL}	—	5.8	10	mA	$V_{CC} = 3.3\text{V}, I_F = 10\text{mA}$
	High Level Output Current	I_{OH}	—	5	100	μA	$V_{CC} = 3.3\text{V}$, $V_O = 3.2\text{V}, I_F = 250\mu\text{A}$
	Low Level Output Voltage	V_{OL}	—	0.3	0.6	V	$V_{CC} = 3.3\text{V}$, $I_F = 5\text{mA}$, $I_{OL} (\text{sinking}) = 13\text{mA}$

Recommended temperature range ($T_A = -40^\circ\text{C} \text{---} +125^\circ\text{C}$, $2.7\text{V} \leq V_{CC} \leq 3.6\text{V}$), $I_F = 7.5\text{mA}$ Unless otherwise stated.
Typical values $T_A = 25^\circ\text{C}$, $V_{CC} = 3.3\text{V}$.

Parameter		Symbol	Min	Typ	Max	Unit	Condition
Input	Forward Voltage	V_F	—	1.38	1.8	V	$I_F=10\text{mA}$ $T_A=25^\circ\text{C}$
	Temperature Coefficient OF Forward Voltage	$\Delta V_F / \Delta T$	—	-1.6	—	mV/°C	$I_F=10\text{mA}$
	Reverse Voltage	BV_R	5	—	—	V	$I_R=10\mu\text{A}$
	Input Threshold Current	I_{TH}	—	1.5	5	mA	$V_{CC}=5.5\text{V}, V_O=0.6\text{V}$ $I_{OL}>13\text{mA}$
	Input Capacitance	C_{IN}	—	34	—	pF	$f=1\text{MHz}, V_F=0\text{V}$
Detector	High Level Supply Current	I_{CCH}	—	6	10	mA	$V_{CC}=5.5\text{V}, I_F=0\text{mA}$
	Low Level Supply Current	I_{CCL}	—	8	13	mA	$V_{CC}=5.5\text{V}, I_F=10\text{mA}$
	High Level Output Current	I_{OH}	—	3	100	μA	$V_{CC}=5.5\text{V}$, $V_O=5.5\text{V}, I_F=250\mu\text{A}$
	Low Level Output Voltage	V_{OL}	—	0.4	0.6	V	$V_{CC}=5.5\text{V}$, $I_F=5\text{mA}$, $I_{OL}(\text{sinking})=13\text{mA}$

Recommended temperature range($T_A = -40^\circ\text{C} \sim +125^\circ\text{C}$, $4.5\text{V} \leq V_{CC} \leq 5.5\text{V}$), $I_F = 7.5\text{mA}$ Unless otherwise stated. Typical values $T_A = 25^\circ\text{C}$, $V_{CC} = 5.0\text{V}$.

8. Switching Characteristics

Parameter	Symbol	Min	Typ	Max	Unit	Condition
Propagation delay time to output High level	t_{PLH}	—	60	90	ns	$R_L=350\Omega$ $C_L=15pF$
Propagation delay time to output Low level	t_{PHL}	—	25	75	ns	
Pulse Width Distortion	$ t_{PLH}-t_{PHL} $	—	35	45	ns	
Output Rise Time (10 to 90%)	t_r	—	27	—	ns	
Output Fall Time (90 to 10%)	t_f	—	6.6	—	ns	
Propagation Delay Skew	t_{PSK}	—	—	40	ns	

Recommended temperature range ($T_A = -40^\circ\text{C} \sim +125^\circ\text{C}$, $2.7\text{V} \leq V_{CC} \leq 3.6\text{V}$), $I_F = 7.5\text{mA}$ Unless otherwise stated.

Typical values $T_A = 25^\circ\text{C}$, $V_{CC} = 3.3\text{V}$.

Parameter	Symbol	Min	Typ	Max	Unit	Condition
Propagation delay time to output High level	t_{PLH}	—	45	75	ns	$R_L=350\Omega$, $C_L=15pF$, $T_A=25^\circ\text{C}$
		—	—	100		
Propagation delay time to output Low level	t_{PHL}	—	25	75	ns	$R_L=350\Omega$, $C_L=15pF$, $T_A=25^\circ\text{C}$
		—	—	100		
Pulse Width Distortion	$ t_{PLH}-t_{PHL} $	—	10	35	ns	$R_L=350\Omega$, $C_L=15pF$
Output Rise Time (10 to 90%)	t_r	—	22	—	ns	
Output Fall Time (90 to 10%)	t_f	—	6.9	—	ns	
Propagation Delay Skew	t_{PSK}	—	—	40	ns	

Recommended temperature range ($T_A = -40^\circ\text{C} \sim +125^\circ\text{C}$, $4.5\text{V} \leq V_{CC} \leq 5.5\text{V}$), $I_F = 7.5\text{mA}$ Unless otherwise stated.

Typical values $T_A = 25^\circ\text{C}$, $V_{CC} = 5.0\text{V}$.

Parameter	Symbol	Part Number	Min	Typ	Max	Unit	Condition
Logic High Common Mode Transient Immunity	CM _H	M600	—	—	—	V/μs	I _F = 7.5mA , V _{OH} =2.0V, R _L =350Ω, T _A =25°C V _{CM} =10Vp-p
		M601	5000	—	—		I _F = 7.5mA , V _{OH} =2.0V, R _L =350Ω, T _A =25°C V _{CM} =50Vp-p
		M611	20000	—	—		I _F = 7.5mA , V _{OH} =2.0V, R _L =350Ω, T _A =25°C V _{CM} =1000Vp-p
Logic Low Common Mode Transient Immunity	CM _L	M600	—	—	—	V/μs	I _F = 0mA , V _{OL} =0.8V, R _L =350Ω, T _A =25°C V _{CM} =10Vp-p
		M601	5000	—	—		I _F = 0mA , V _{OL} =0.8V, R _L =350Ω, T _A =25°C V _{CM} =50Vp-p
		M611	20000	—	—		I _F = 0mA , V _{OL} =0.8V, R _L =350Ω, T _A =25°C V _{CM} =1000Vp-p

Parameter	Symbol	Min	Typ	Max	Unit	Condition
Input-Output Insulation Leakage Current	II-O	—	—	1	μA	45% RH,t=5s, VI-O = 3kV DC,TA =25 C
Withstand Insulation Test Voltage	VISO	3750	—	—	VRMS	RH ≤ 50%, t =1min,TA=25°C
Input-Output Resistance	RI-O	—	10 ¹²	—	Ω	VI-O = 500V DC
Input-Output Capacitance	CI-O	—	1	—	p	f = 1MHz, TA = 25 C

Recommended temperature range (T_A=40°C-125°C) Unless otherwise stated. Typical values T_A=25°C.



9. Order Information

Part Number

OR-M6XX-W-Y-Z

Note

XX = Type code. ('00', '01', '11')

W = Tape and reel option. (TP or TP1).

Y = 'V' code for VDE safety (This options is not necessary).

Z = 'G' code for Halogen free.

* VDE Code can be selected.

Option	Description	Packing quantity
TP	Surface mount lead form (low profile) + TP tape & reel option	3000 units per reel
TP1	Surface mount lead form (low profile) + TP1 tape & reel option	3000 units per reel

10. Naming Rule

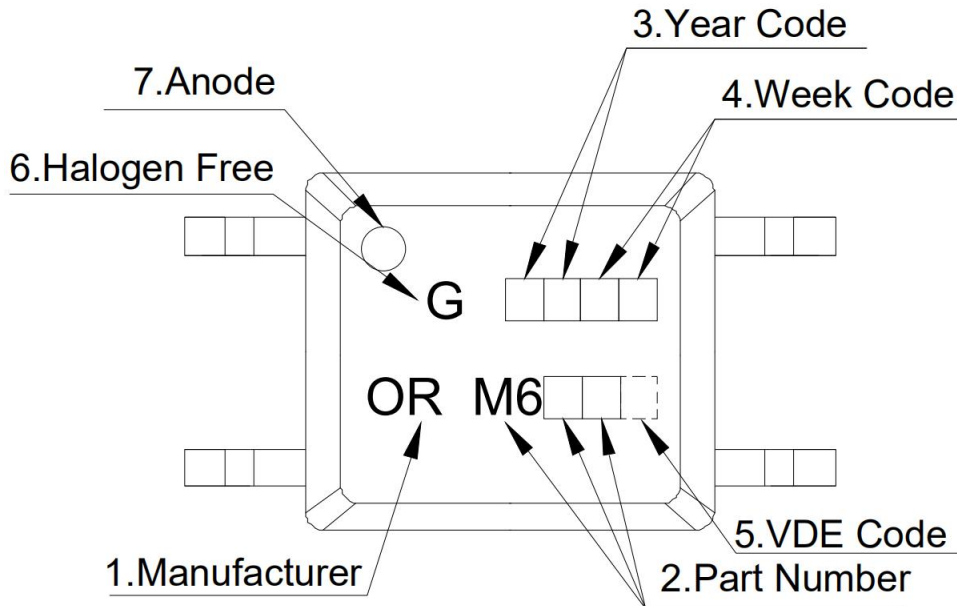

1. Manufacturer : ORIENT.

2. Part Number : M600, M601 or M611.

3. Year Code : '21' means '2021' and so on.

4. Week Code : 01 means the first week, 02 means the second week and so on.

5. VDE Code . (Optional)

6. HF Code 'G': Halogen Free.

7. Anode.

* VDE Code can be selected.

11. Outer Dimension

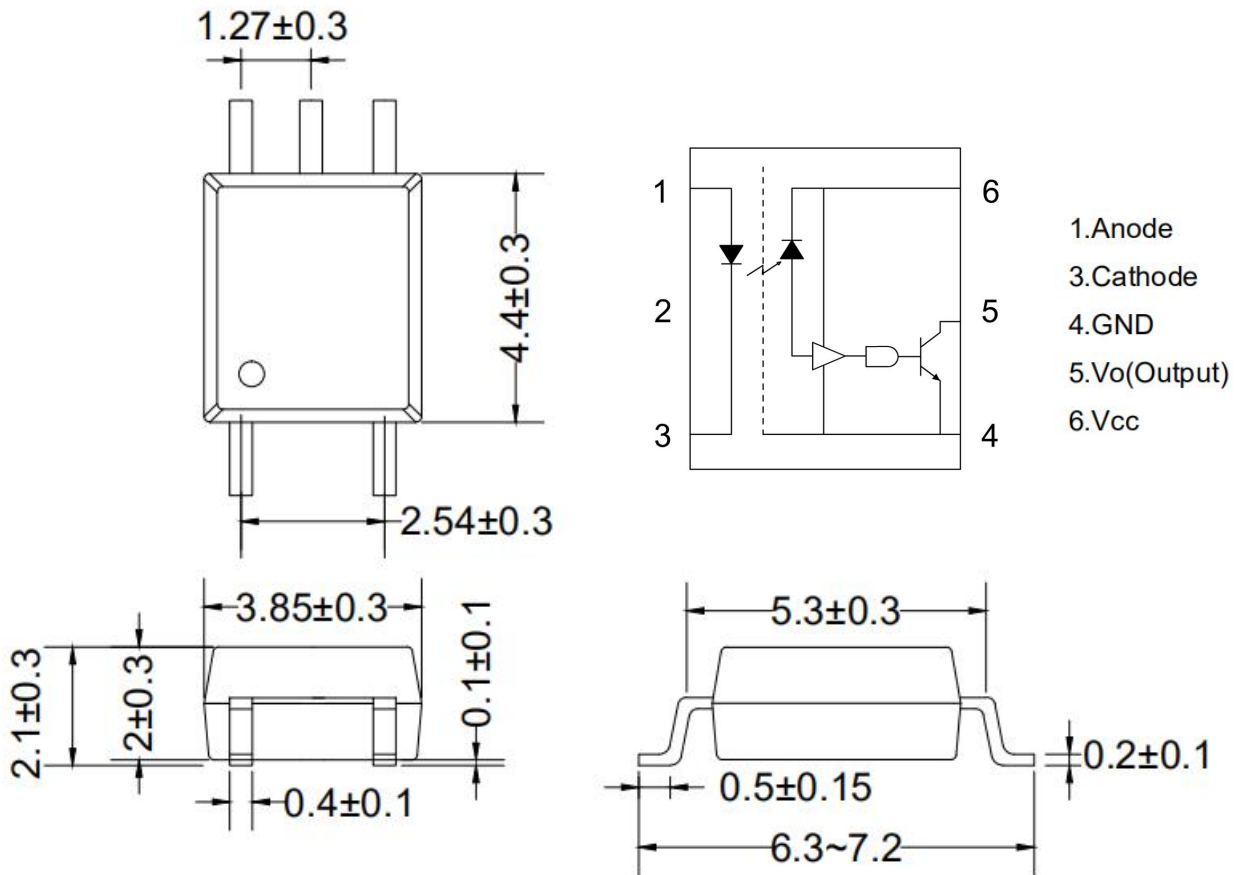

12. Recommended Foot Print Patterns (Mount Pad)

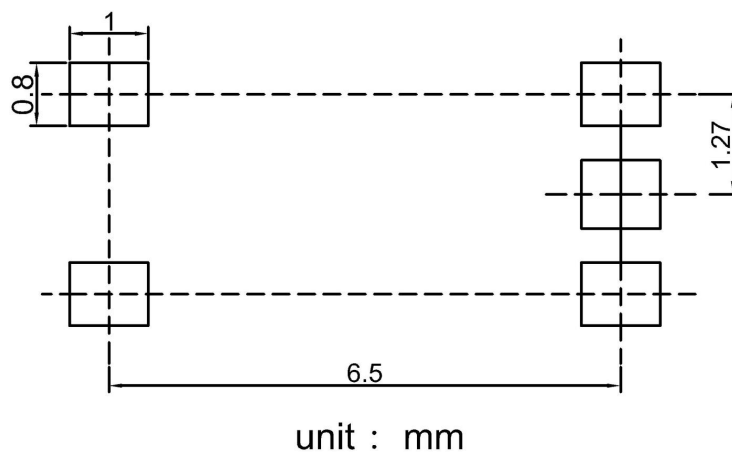

13. Taping Dimensions

(1) OR-M6XX-TP

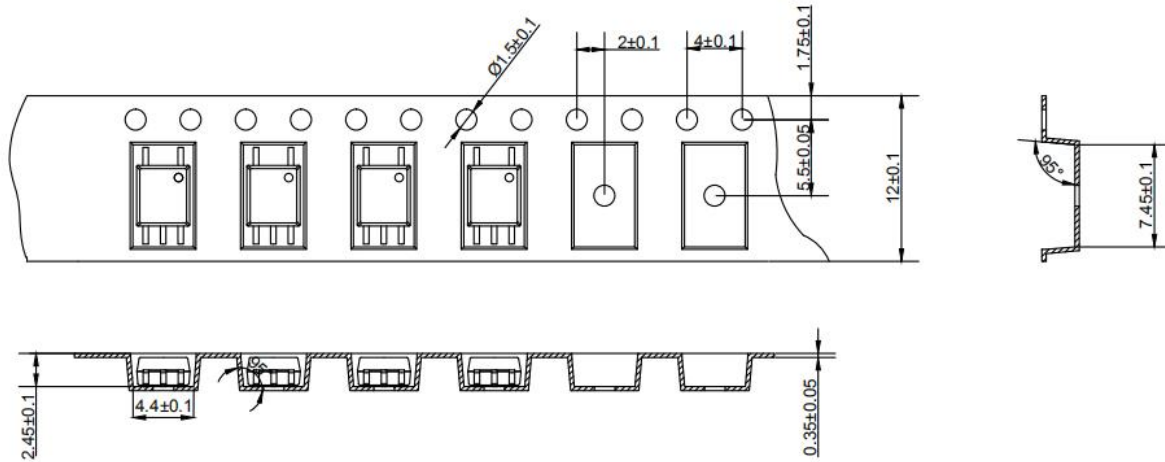

(2) OR-M6XX-TP1

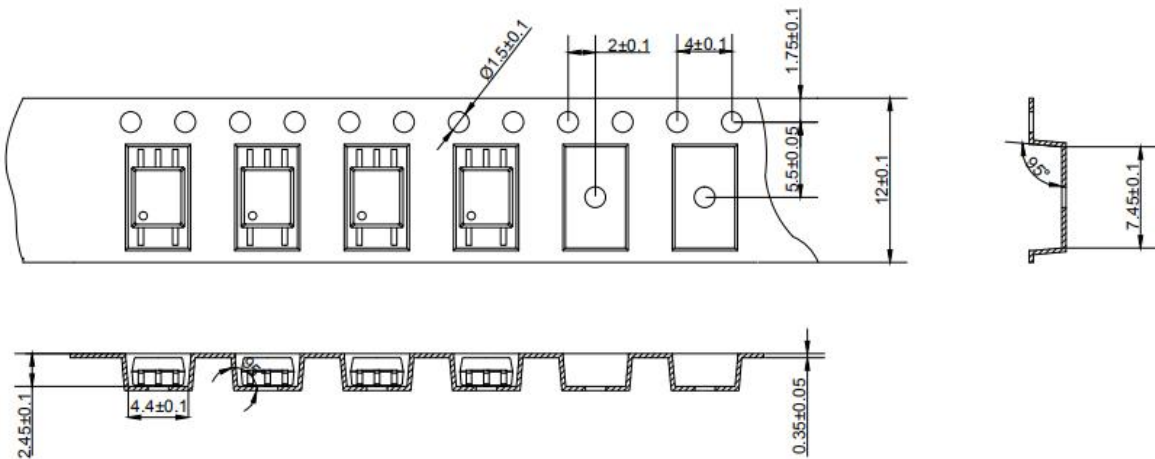

Description	Symbol	Dimension in mm(inch)
Tape wide	W	12 ± 0.3 (0.472)
Pitch of sprocket holes	P0	4 ± 0.1 (0.157)
Distance of compartment	F	5.5 ± 0.1 (0.217)
	P2	2 ± 0.1 (0.079)
Distance of compartment to compartment	P1	8 ± 0.1 (0.315)

Encapsulation type	TP/TP1
amount (pcs)	3000

14. Package Dimension

(1) package dimension

Packing Information	
Packing type	Reel type
Tape Width	12mm
Qty per Reel	3,000pcs
Small box (inner) Dimension	345*345*45mm
Large box (Outer) Dimension	480x360x360mm
Max qty per small box	6,000pcs
Max qty per large box	60,000pcs

(2) Packing Label Sample



Note:

1. Material Code :Product ID.
2. P/N :Contents with "Order Information" in the specification.
3. Lot No. :Product data.
4. D/C :Product weeks.
5. Quantity :Packaging quantity.

15. Reliability Test

NO.	ITEMS	Reliability Testing				
		QTY. (Pcs)	Condition	Process	Device	Standard
1	RSH 耐焊接热	22	260±5°C	5s/3 次	锡炉	JESD22-A106
2	HTSL 高温存储	77	125°C	168 hrs	高温烤箱 测试仪	JESD22-A103
				500 hrs		
				1000 hrs		
3	LTSL 低温存储	77	-40°C	168 hrs	低温箱 测试仪	JESD22-A119
				500 hrs		
				1000 hrs		
4	TC 温度循环	77	H:125°C 15min ↓5min L:-55°C 15min	300 cycle	冷热冲击 机	JESD22-A104
5	TS 温度冲击	77	H:100°C 5min ↓15s L:-40°C 5min	300 cycle	冷热冲击 机	JESD22-A106
6	HTOL 高温操作	77	100°C IF=10mA Vcc=5V	168 hrs	高温烤箱 测试仪、 老化电 路板	JESD22-A108
				500 hrs		
				1000 hrs		
7	ESD-HB M 人体模式	22	≥8KV 1Cycle	1 次	ESD 静 电测试 仪	JESD22-A114
8	SD 可焊性	22	Pb-free 245±5°C	5s/1 次	锡炉	JESD22-B102
9	HTHB 温湿寿命 试验	77	85°C,85%RH IF=10mA,Vcc=5V	168 hrs	恒温恒湿 机, 测试 仪	JESD22-A101
				500 hrs		
				1000 hrs		
10	Autoclave 压力锅	77	Ta=121 °C,100%RH,2atm	96hrs	压力锅	JESD22-A102

16. Temperature Profile Of Soldering

(1) IR Reflow soldering (JEDEC-STD-020C compliant)

Note: one solder backflow is recommended under the conditions described below in the temperature and time profile. Do not weld more than three times.

Profile item	Conditions
Preheat	
- Temperature Min (T Smin)	150°C
- Temperature Max (T Smax)	200°C
- Time (min to max) (ts)	90±30 sec
Soldering zone	
- Temperature (TL)	217°C
- Time (t L)	60 sec
Peak Temperature	260°C
Peak Temperature time	20 sec
Ramp-up rate	3°C / sec max.
Ramp-down rate from peak temperature	3~6°C / sec
Reflow times	≤3

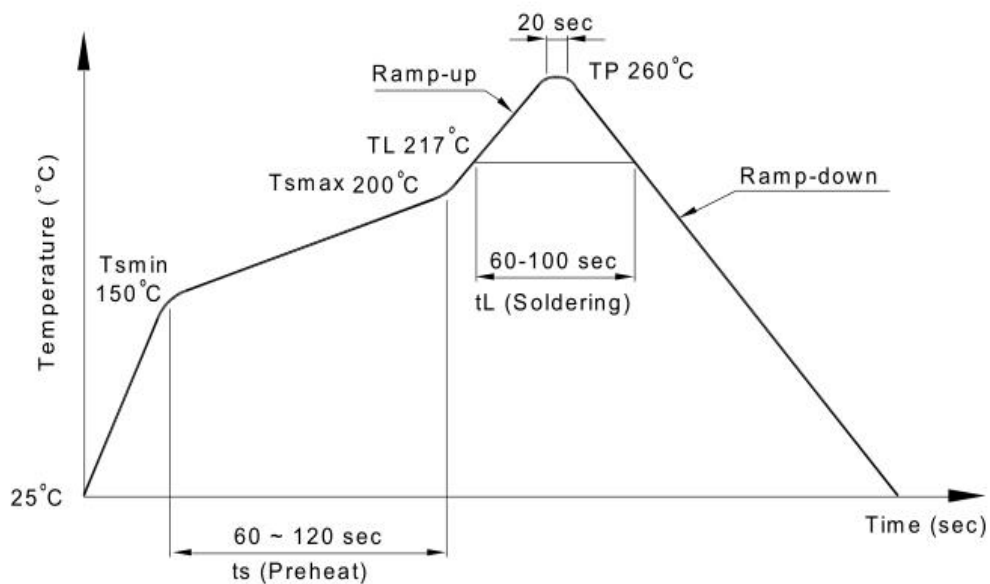

(2) Wave soldering (JEDEC22A111 compliant)

One-time welding is recommended under the temperature condition.

Temperature	260+0/-5°C
Time	10 sec
Preheat temperature	5 to 140°C
Preheat time	30 to 80 sec

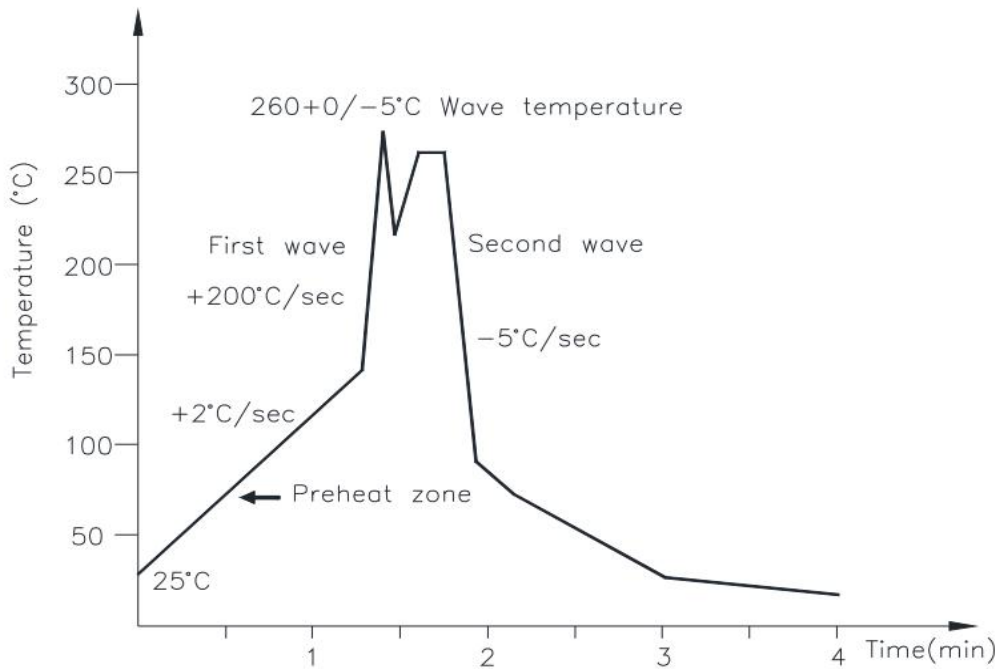

(3) Hand soldering by soldering iron

Single lead welding is allowed in each process and one-time welding is recommended.

Temperature	380+0/-5°C
Time	3 sec max

17. Switching time test circuit

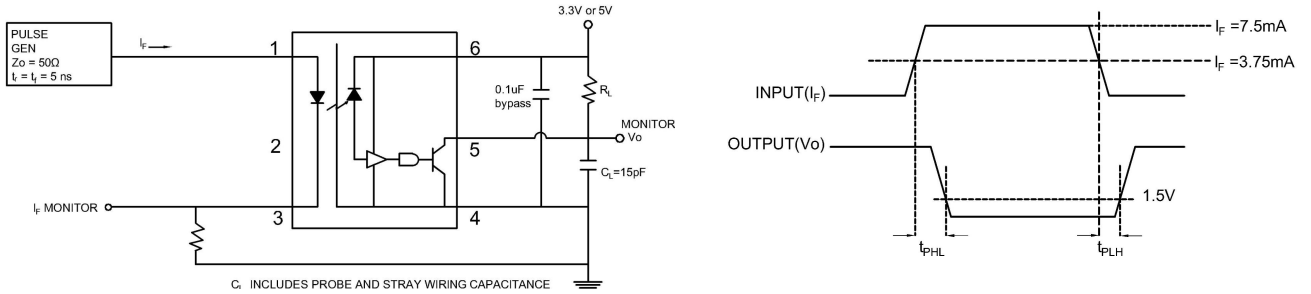

Figure 1: Test Circuit for T_{PHL} and T_{PLH}

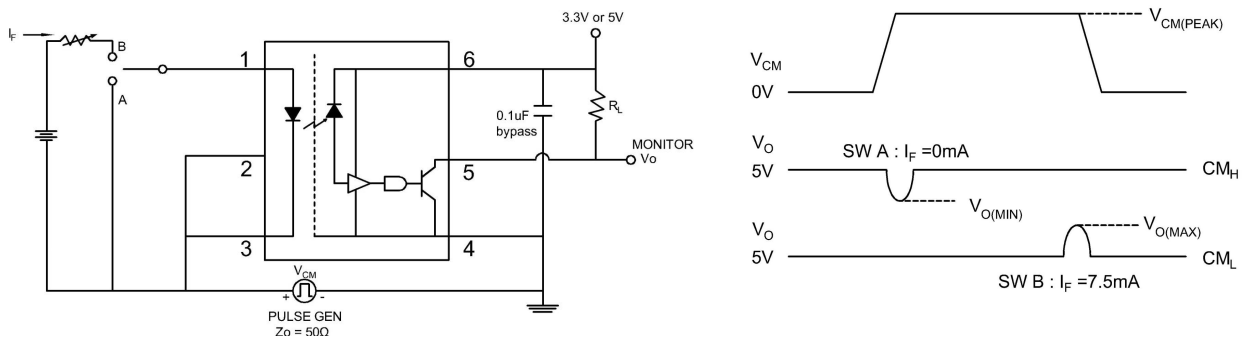

Figure 2: Single Channel Test Circuit for Common Mode Transient Immunity

18. Characteristics Curve

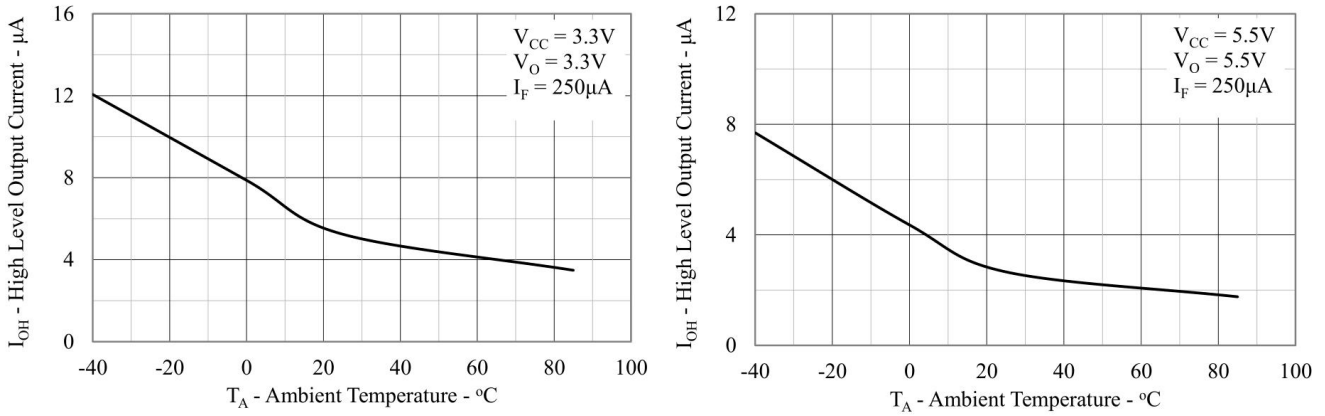

Figure 3: Typical high level output current vs. temperature.

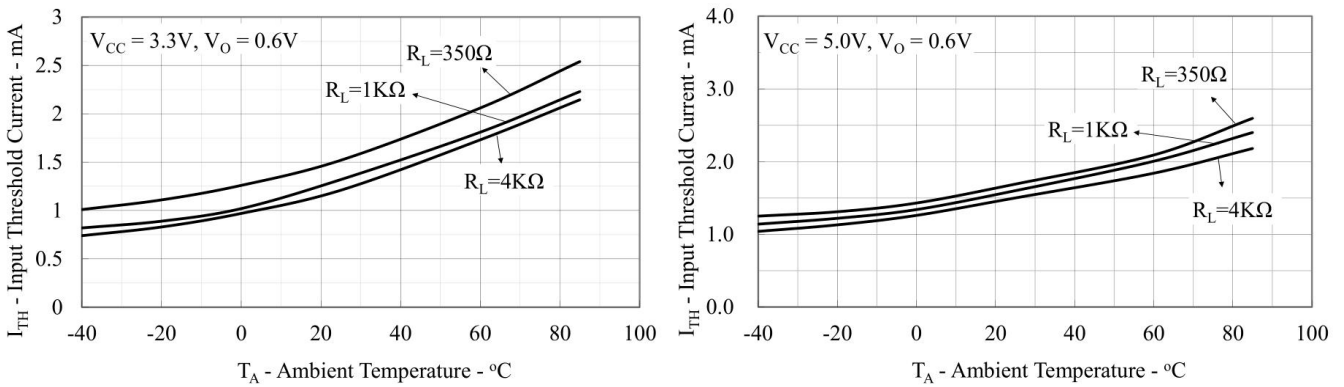

Figure 4: Typical Input Diode Threshold Current vs. Ambient Temperature

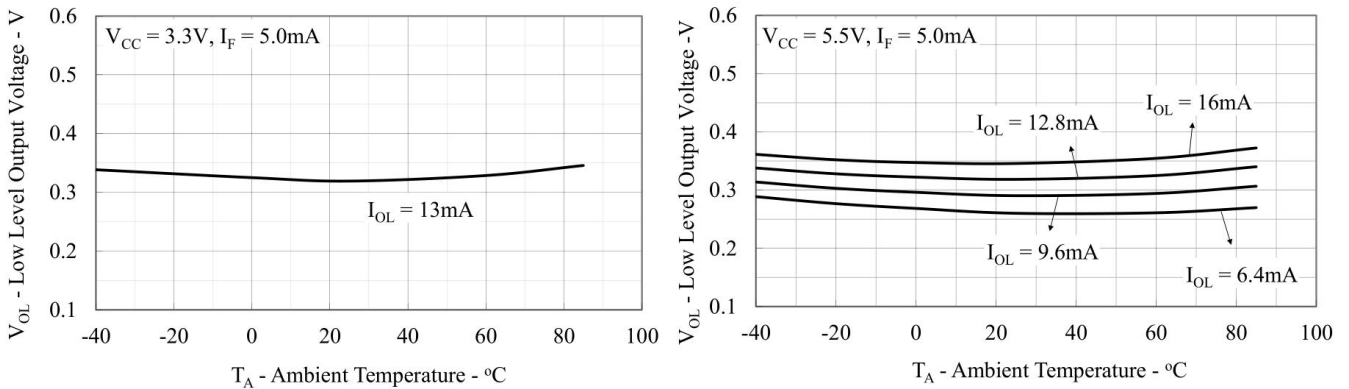

Figure 5: Typical Low Level Output Voltage vs. Ambient Temperature

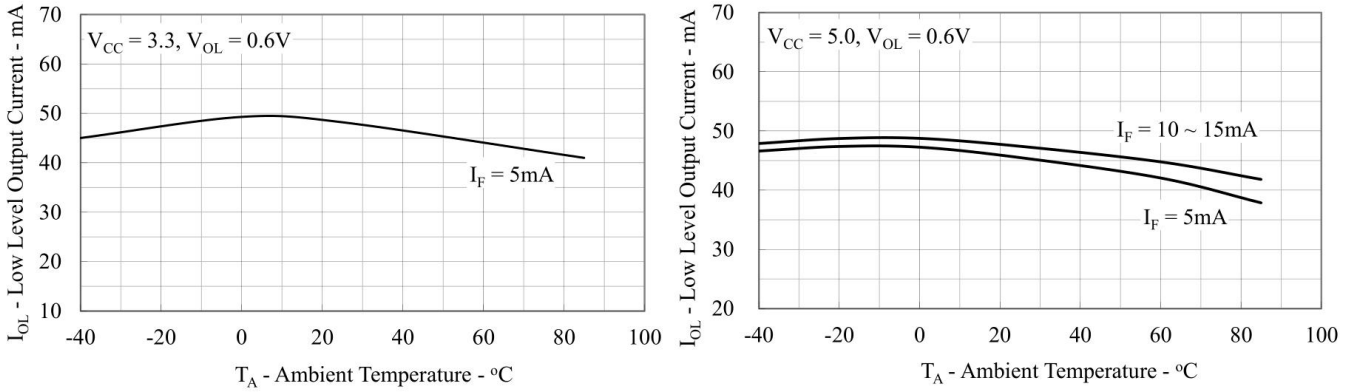

Figure 6: Typical Low Level Output Current vs. Ambient Temperature

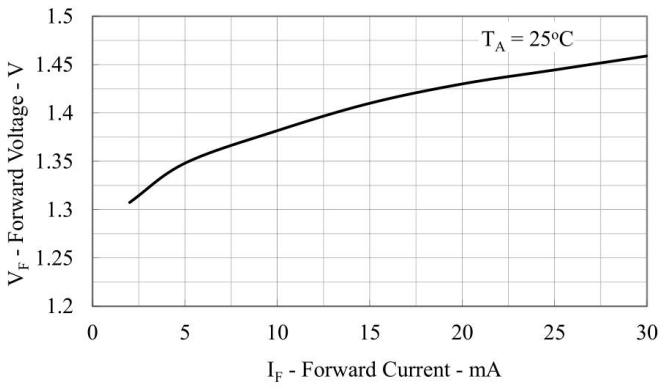

Figure 7: Typical Input Diode Forward Characteristics

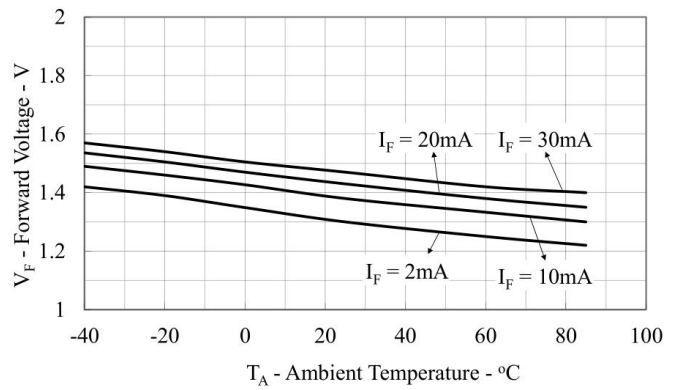

Figure 8: Typical Input Diode Forward Voltage vs. Ambient Temperature

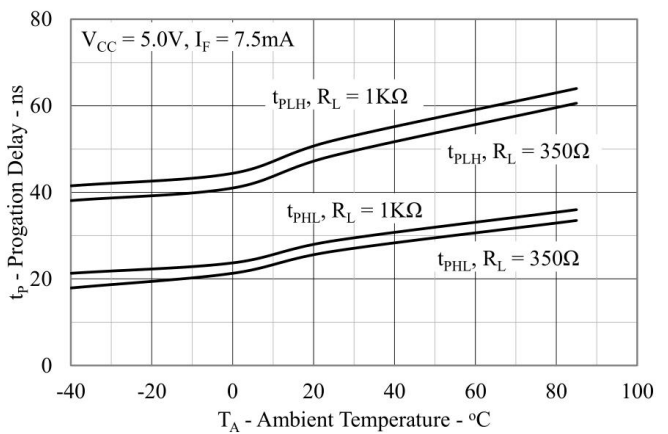
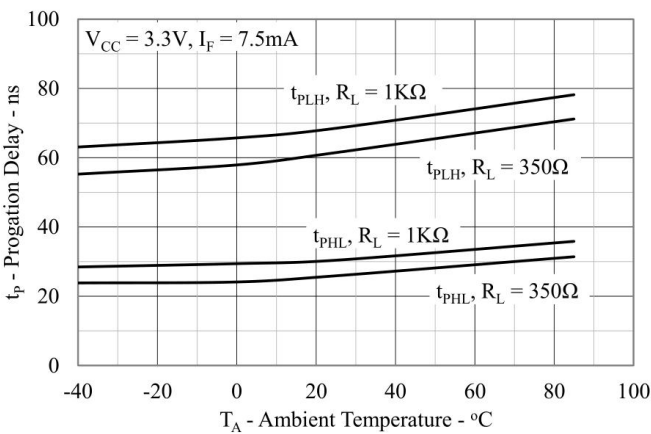

Figure 9: Typical Propagation Delay vs. Ambient Temperature

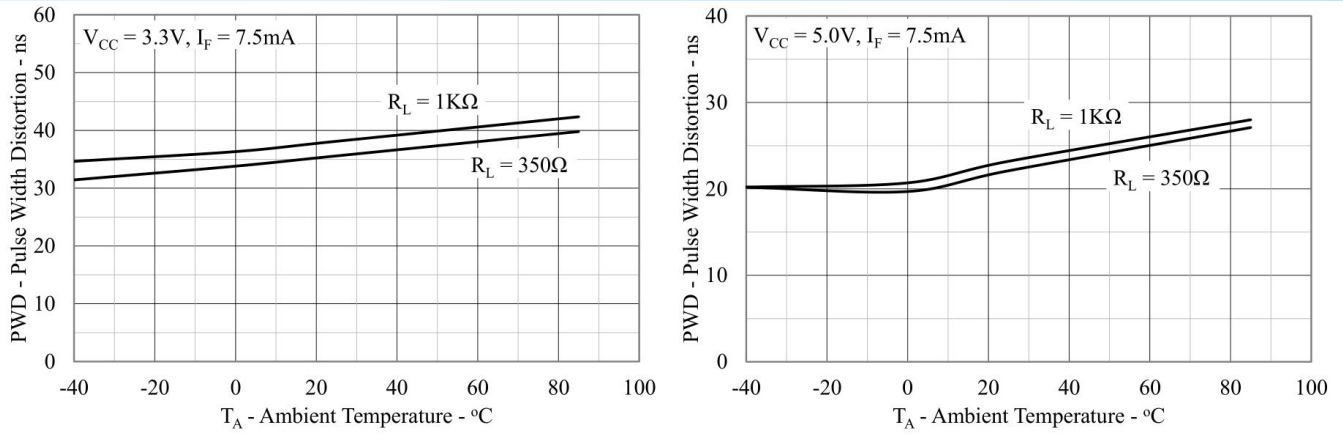

Figure 10: Typical Pulse Width Distortion vs. Ambient

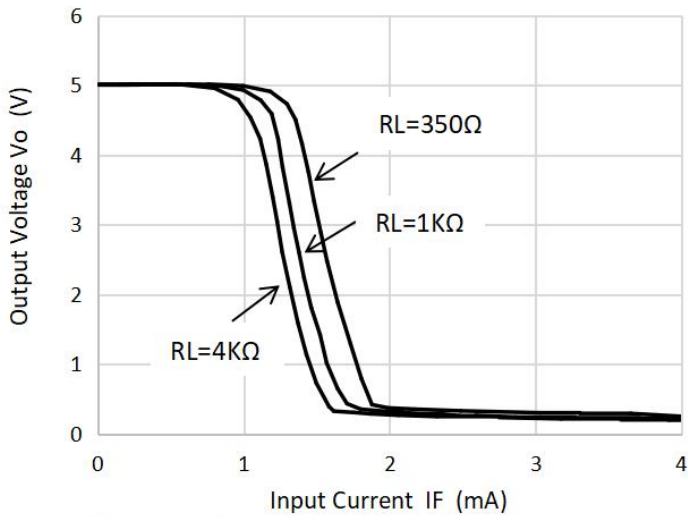

Figure 11: Input Current vs Output Voltage