

IGBT Modules

V_{CES}	1200V
I_C	15A

Applications

- Motor Drivers
- AC and DC servo drive amplifier
- UPS (Uninterruptible Power Supplies)

Features

- Low switching losses
- Low $V_{ce(sat)}$ with positive temperature coefficient
- Including fast & soft recovery anti-parallel FWD
- Low inductance case
- High short circuit capability(10us)
- Isolated heatsink using DBC technology
- Maximum junction temperature 175°C

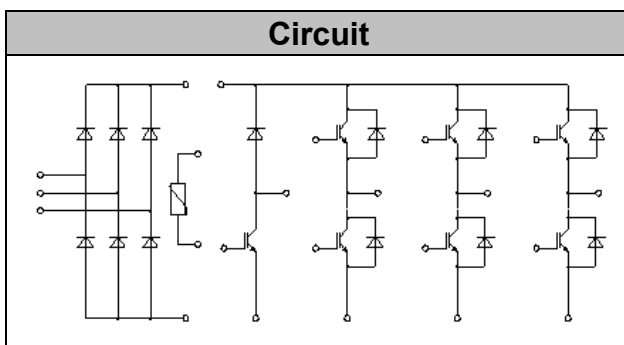

IGBT- inverter

Absolute Maximum Ratings

Parameter	Symbol	Conditions	Value	Unit
Collector-Emitter Voltage	V_{CES}	$V_{GE}=0V, I_C = 1mA, T_{vj}=25^{\circ}C$	1200	V
Continuous Collector Current	I_C	$T_c=100^{\circ}C, T_{vjmax}=175^{\circ}C$	15	A
Repetitive Peak Collector Current	I_{CRM}	$t_p=1ms$	30	A
Gate-Emitter Voltage	V_{GES}	$T_{vj}=25^{\circ}C$	± 20	V
Total Power Dissipation	P_{tot}	$T_c=25^{\circ}C$ $T_{vjmax}=175^{\circ}C$	155	W



IGBT- inverter Characteristic values

Parameter	Symbol	Conditions	Value			Unit	
			Min.	Typ.	Max.		
Gate-emitter Threshold Voltage	$V_{GE(th)}$	$V_{GE}=V_{CE}, I_C=0.5mA, T_{vj}=25^{\circ}C$	5.2	6.0	6.8	V	
Collector-Emitter Cut-off Current	I_{CES}	$V_{CE}=1200V, V_{GE}=0V, T_{vj}=25^{\circ}C$			1.0	mA	
Collector-Emitter Saturation Voltage	$V_{CE(sat)}$	$I_C=15A, V_{GE}=15V, T_{vj}=25^{\circ}C$		1.80	2.20	V	
		$I_C=15A, V_{GE}=15V, T_{vj}=125^{\circ}C$		2.10			
		$I_C=15A, V_{GE}=15V, T_{vj}=150^{\circ}C$		2.20			
Gate Charge	Q_G			0.15		uC	
Input Capacitance	C_{ies}	$V_{CE}=25V, V_{GE}=0V,$		1.1		nF	
Reverse Transfer Capacitance	C_{res}	$f=1MHz, T_{vj}=25^{\circ}C$		0.04		nF	
Gate-Emitter leakage current	I_{GES}	$V_{CE}=0V, V_{GE}=20V, T_{vj}=25^{\circ}C$			400	nA	
Turn-on Delay Time	$t_{d(on)}$	$I_C=15A$ $V_{CE}=600V$ $V_{GE}=\pm 15V$ $R_G=39\Omega$ $T_{vj}=25^{\circ}C$		90		ns	
Rise Time	t_r			64		ns	
Turn-off Delay Time	$t_{d(off)}$			180		ns	
Fall Time	t_f			135		ns	
Energy Dissipation During Turn-on Time	E_{on}			1.42		mJ	
Energy Dissipation During Turn-off Time	E_{off}			0.78		mJ	
Turn-on Delay Time	$t_{d(on)}$		$I_C=15A$ $V_{CE}=600V$ $V_{GE}=\pm 15V$ $R_G=39\Omega$ $T_{vj}=125^{\circ}C$		95		ns
Rise Time	t_r				70		ns
Turn-off Delay Time	$t_{d(off)}$				260		ns
Fall Time	t_f				180		ns
Energy Dissipation During Turn-on Time	E_{on}			1.85		mJ	
Energy Dissipation During Turn-off Time	E_{off}			1.13		mJ	
SC Data	I_{sc}	$T_p \leq 10\mu s, V_{GE}=15V, T_{vj}=150^{\circ}C,$ $V_{cc}=900V, V_{CEM} \leq 1200V$			90		A



Diode-inverter Absolute Maximum Ratings

Parameter	Symbol	Conditions	Value	Unit
Repetitive Peak Reverse Voltage	V_{RRM}	$T_{vj}=25^{\circ}C$	1200	V
Continuous DC Forward Current	I_F		15	A
Repetitive Peak Forward Current	I_{FRM}	$t_p=1ms$	30	A
I^2t -value	I^2t	$V_R=0, t_p=10ms, T_{vj}=125^{\circ}C$	16.0	A^2s
		$V_R=0, t_p=10ms, T_{vj}=150^{\circ}C$	14.0	

Characteristic values

Parameter	Symbol	Conditions	Value			Unit
			Min.	Typ.	Max.	
Forward Voltage	V_F	$I_F=15A, T_{vj}=25^{\circ}C$		2.00	2.65	V
		$I_F=15A, T_{vj}=125^{\circ}C$		2.10		
		$I_F=15A, T_{vj}=150^{\circ}C$		2.10		
Recovered Charge	Q_{rr}	$I_F=15A$		1.20		μC
Peak Reverse Recovery Current	I_{rr}	$V_R=600V$ $-di_F/dt=600A/\mu s$		13.0		A
Reverse Recovery Energy	E_{rec}	$T_{vj}=25^{\circ}C$		0.37		mJ
Recovered Charge	Q_{rr}	$I_F=15A$		2.05		μC
Peak Reverse Recovery Current	I_{rr}	$V_R=600V$ $-di_F/dt=600A/\mu s$		12.0		A
Reverse Recovery Energy	E_{rec}	$T_{vj}=125^{\circ}C$		0.68		mJ



IGBT-brake-chopper Absolute Maximum Ratings

Parameter	Symbol	Conditions	Value	Unit
Collector-Emitter Voltage	V_{CES}	$V_{GE}=0V, I_C=1mA, T_{vj}=25^{\circ}C$	1200	V
Continuous Collector Current	I_C	$T_c=100^{\circ}C, T_{vjmax}=175^{\circ}C$	15	A
Repetitive Peak Collector Current	I_{CRM}	$tp=1ms$	30	A
Gate-Emitter Voltage	V_{GES}	$T_{vj}=25^{\circ}C$	± 20	V
Total Power Dissipation	P_{tot}	$T_c=25^{\circ}C, T_{vjmax}=175^{\circ}C$	155	W

Characteristic values

Parameter	Symbol	Conditions	Value			Unit
			Min.	Typ.	Max.	
Gate-emitter Threshold Voltage	$V_{GE(th)}$	$V_{GE}=V_{CE}, I_C=0.5mA, T_{vj}=25^{\circ}C$	5.2	6.0	6.8	V
Collector-Emitter Cut-off Current	I_{CES}	$V_{CE}=1200V, V_{GE}=0V, T_{vj}=25^{\circ}C$			1.0	mA
Collector-Emitter Saturation Voltage	$V_{CE(sat)}$	$I_C=15A, V_{GE}=15V, T_{vj}=25^{\circ}C$		1.85	2.25	V
		$I_C=15A, V_{GE}=15V, T_{vj}=125^{\circ}C$		2.15		
		$I_C=15A, V_{GE}=15V, T_{vj}=150^{\circ}C$		2.25		
Gate Charge	Q_G			0.09		μC
Input Capacitance	C_{ies}	$V_{CE}=25V, V_{GE}=0V,$		1.35		nF
Reverse Transfer Capacitance	C_{res}	$f=1MHz, T_{vj}=25^{\circ}C$		0.08		nF
Gate-Emitter leakage current	I_{GES}	$V_{CE}=0V, V_{GE}=20V, T_{vj}=25^{\circ}C$			400	nA
Turn-on Delay Time	$t_{d(on)}$	$I_C=15A$ $V_{CE}=600V$ $V_{GE}=\pm 15V$ $R_G=39\Omega$ $T_{vj}=25^{\circ}C$		46		ns
Rise Time	t_r			45		ns
Turn-off Delay Time	$t_{d(off)}$			182		ns
Fall Time	t_f			168		ns
Energy Dissipation During Turn-on Time	E_{on}			0.92		mJ
Energy Dissipation During Turn-off Time	E_{off}			0.56		mJ



Turn-on Delay Time	$t_{d(on)}$	$I_C = 15A$ $V_{CE} = 600V$ $V_{GE} = \pm 15V$ $R_G = 39\Omega$ $T_{vj} = 125^\circ C$		46		ns
Rise Time	t_r			63		ns
Turn-off Delay Time	$t_{d(off)}$			248		ns
Fall Time	t_f			220		ns
Energy Dissipation During Turn-on Time	E_{on}			1.37		mJ
Energy Dissipation During Turn-off Time	E_{off}			0.81		mJ
SC Data	I_{sc}	$T_p \leq 10\mu s, V_{GE} = 15V, T_{vj} = 150^\circ C,$ $V_{ec} = 900V, V_{CEM} \leq 1200V$		90		A

Diode-Brake-Chopper

Absolute Maximum Ratings

Parameter	Symbol	Conditions	Value	Unit
Repetitive Peak Reverse Voltage	V_{RRM}	$T_j = 25^\circ C$	1200	V
Continuous DC Forward Current	I_F		10	A
Repetitive Peak Forward Current	I_{FRM}	$t_p = 1ms$	20	A
I^2t -value	I^2t	$V_R = 0, t_p = 10ms, T_j = 125^\circ C$	16.0	A ² s
		$V_R = 0, t_p = 10ms, T_j = 150^\circ C$	14.0	

Characteristic values

Parameter	Symbol	Conditions	Value			Unit
			Min.	Typ.	Max.	
Forward Voltage	V_F	$I_F = 10A, T_{vj} = 25^\circ C$		2.00	2.50	V
		$I_F = 10A, T_{vj} = 125^\circ C$		2.10		
		$I_F = 10A, T_{vj} = 150^\circ C$		2.10		
Recovered Charge	Q_{rr}	$I_F = 10A$		0.90		μC
Peak Reverse Recovery Current	I_{rr}	$V_R = 600V$ $-di_F/dt = 500A/\mu s$		12.5		A
Reverse Recovery Energy	E_{rec}	$T_{vj} = 25^\circ C$		0.25		mJ
Recovered Charge	Q_{rr}	$I_F = 10A$		1.70		μC
Peak Reverse Recovery Current	I_{rr}	$V_R = 600V$ $-di_F/dt = 500A/\mu s$		10.4		A
Reverse Recovery Energy	E_{rec}	$T_{vj} = 125^\circ C$		0.50		mJ



Diode-Rectifier Absolute Maximum Ratings

Parameter	Symbol	Conditions	Value	Unit
Repetitive Peak Reverse Voltage	V_{RRM}	$T_j=25^{\circ}\text{C}$	1600	V
Average output Current 50/60Hz, sine wave	$I_{F(AV)}$	$T_c=100^{\circ}\text{C}$	20	A
Maximum RMS Current at Rectifier Output	I_{RMSM}	$T_c=100^{\circ}\text{C}$	40	A
Surge Forward Current	I_{FSM}	$V_R=0, t_p=10\text{ms}, T_j=45^{\circ}\text{C}$	270	A
I^2t -value	I^2t	$V_R=0, t_p=10\text{ms}, T_j=45^{\circ}\text{C}$	360	A^2s

Characteristic values

Parameter	Symbol	Conditions	Value			Unit
			Min.	Typ.	Max.	
Diode Forward Voltage	V_F	$I_F=15\text{A}, T_j=150^{\circ}\text{C}$		0.96		V
Reverse Current	I_R	$T_j=150^{\circ}\text{C}, V_R=1600\text{V}$			1.0	mA

NTC-Thermistor

Characteristic values

Parameter	Symbol	Conditions	Value			Unit
			Min.	Typ.	Max.	
Rated Resistance	R_{25}			5.0		$\text{k}\Omega$
Deviation of R_{100}	$\Delta R/R$	$T_c=100, R_{100}=493.3\Omega$	-5		5	%
Power Dissipation	P_{25}				20.0	mW
B-value	$B_{25/50}$	$R_2=R_{25}\exp[B_{25/50}(1/T_2-1/(298.15\text{K}))]$		3375		K



Module Characteristics (T_C=25°C unless otherwise specified)

Parameter	Symbol	Conditions	Value			Unit
			Min.	Typ.	Max.	
Isolation voltage	V _{isol}	t=1min, f=50Hz	2500			V
Maximum Junction Temperature	T _{Jmax}				175	°C
Operating Junction Temperature	T _{vj op}		-40		150	°C
Storage Temperature	T _{stg}		-40		125	°C
Stray-inductance-module	L _{SCE}			30		nH
Module lead resistance, terminals-chip	R _{CC+EE'}	T _C =25°C, per switch		8.00		mΩ
	R _{AA+CC'}			6.00		
Thermal Resistance Junction-to Case	R _{θJC}	per IGBT-inverter		0.95	1.05	K/W
		per Diode-inverter		1.30	1.45	
		per IGBT-brake-copper		0.95	1.05	
		per Diode-chopper		1.75	1.90	
		per Diode-rectifier		1.03	1.13	
Thermal Resistance Case-to Sink	R _{θCS}	per IGBT-inverter		0.95		K/W
		per Diode-inverter		1.05		
		per IGBT-brake-copper		0.95		
		per Diode-chopper		1.30		
		per Diode-rectifier		1.17		
		per Module		0.058		
Mounting Force Per Clamp	F		20		50	N
Weight of Module	G			25		g

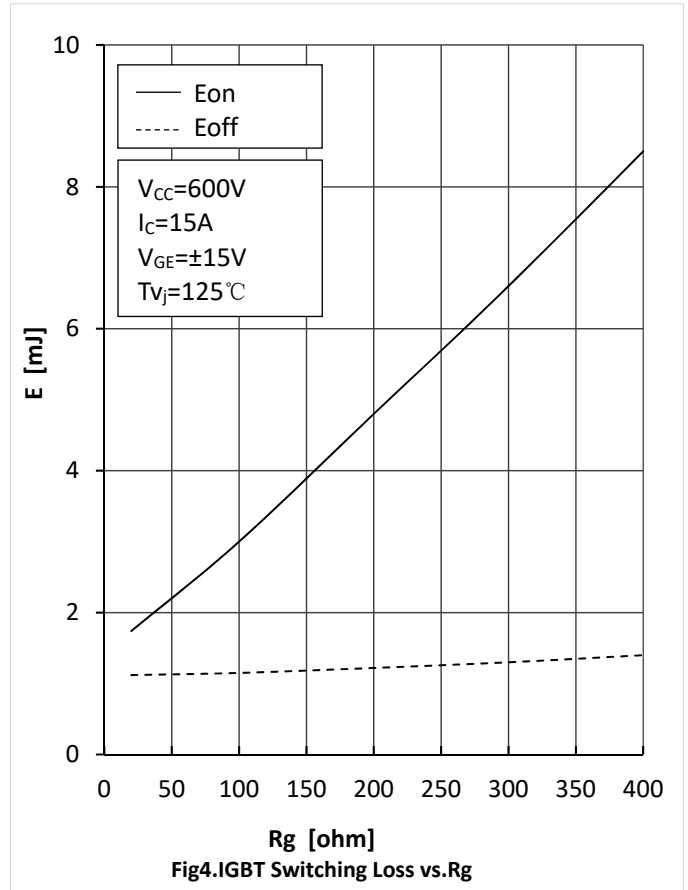
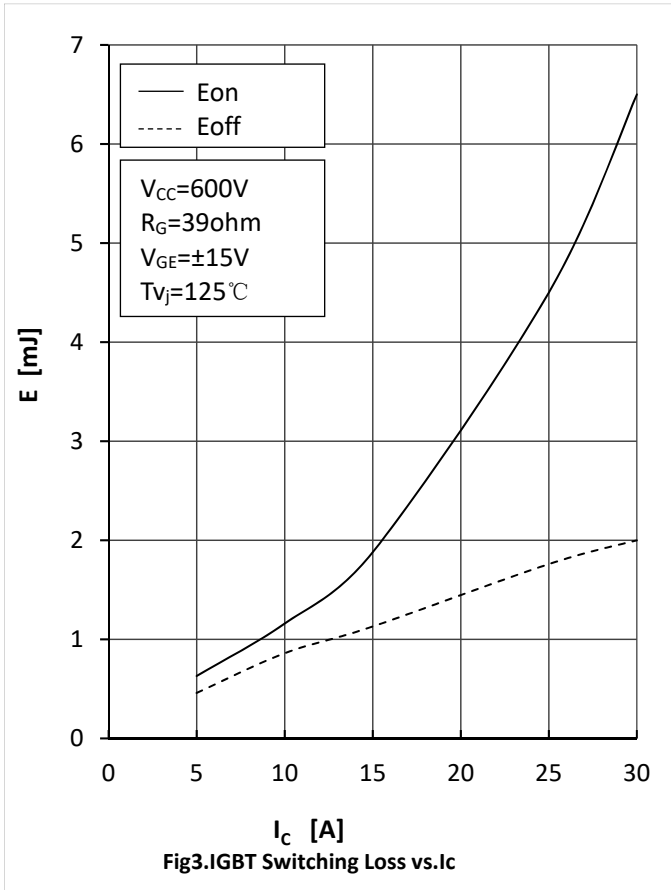
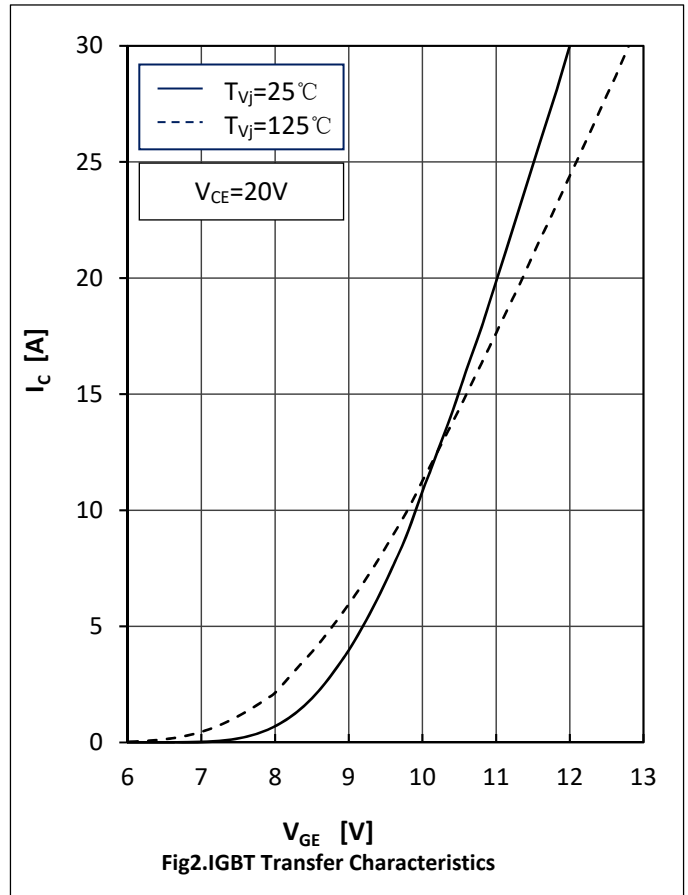
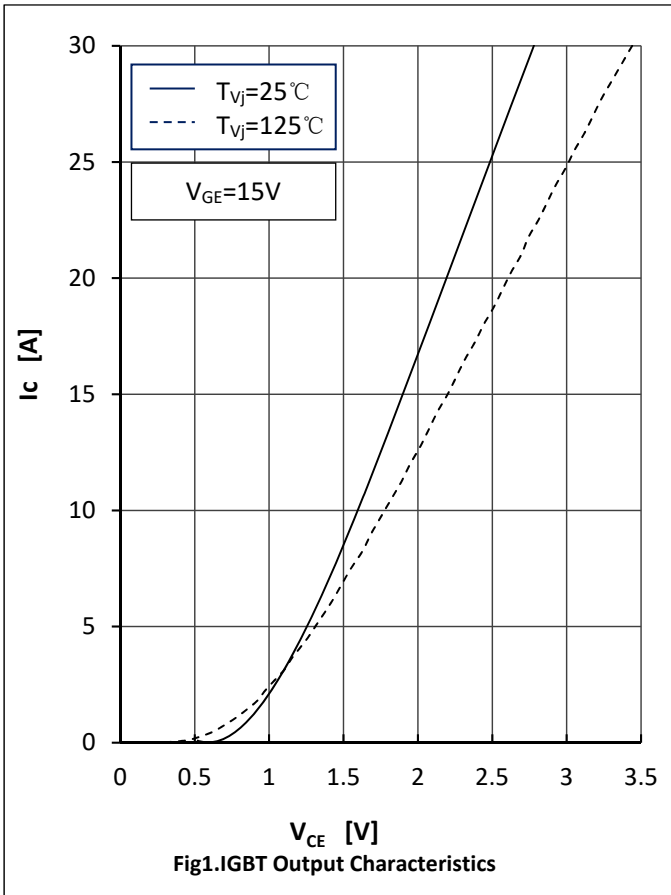

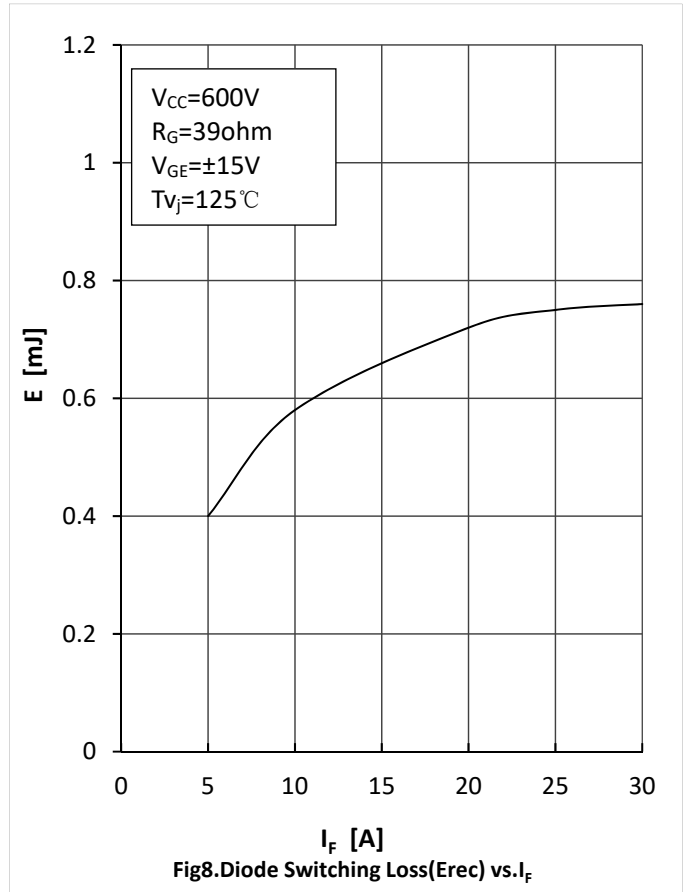
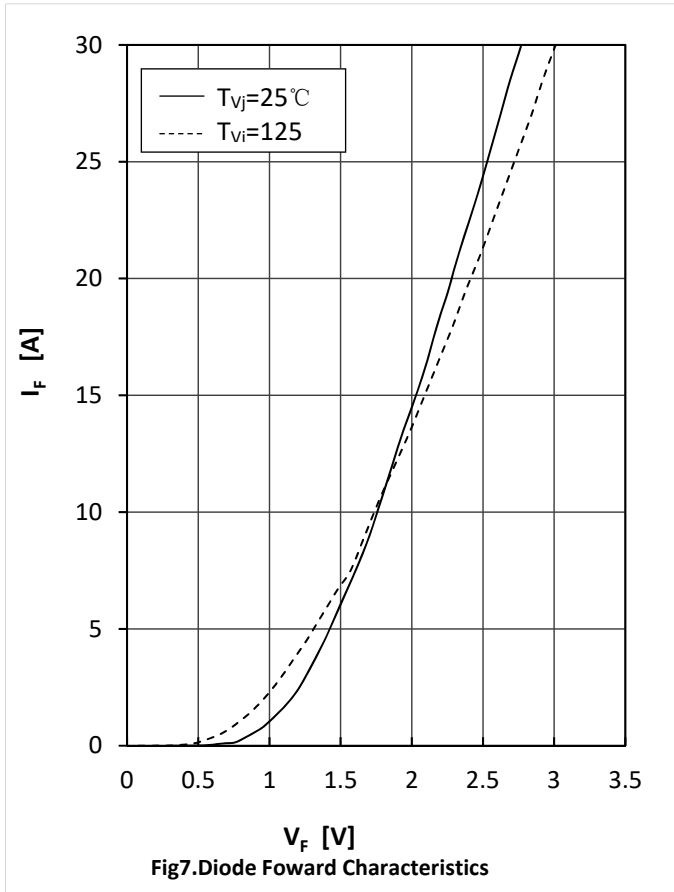
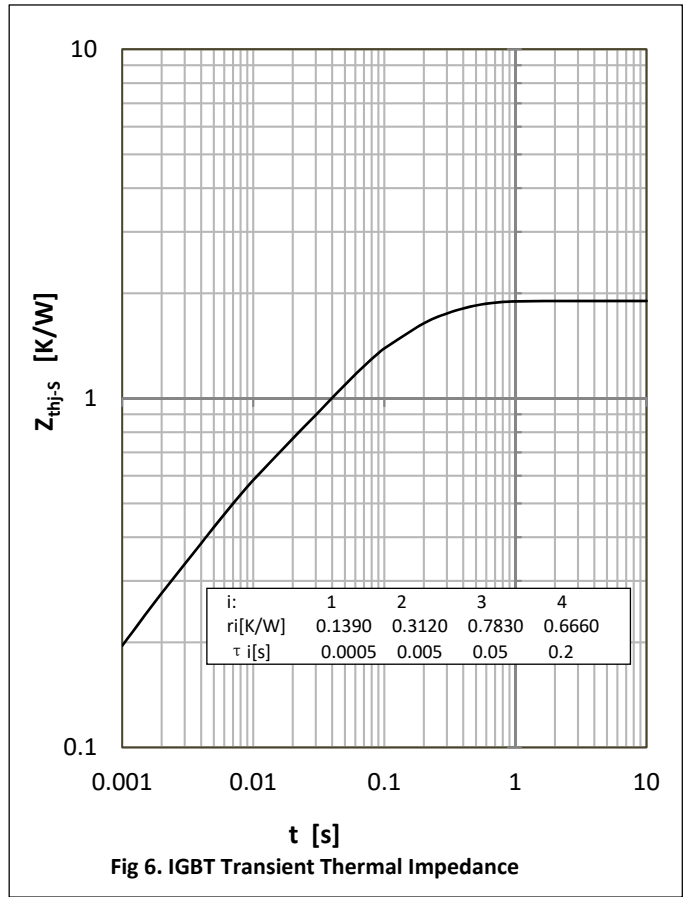
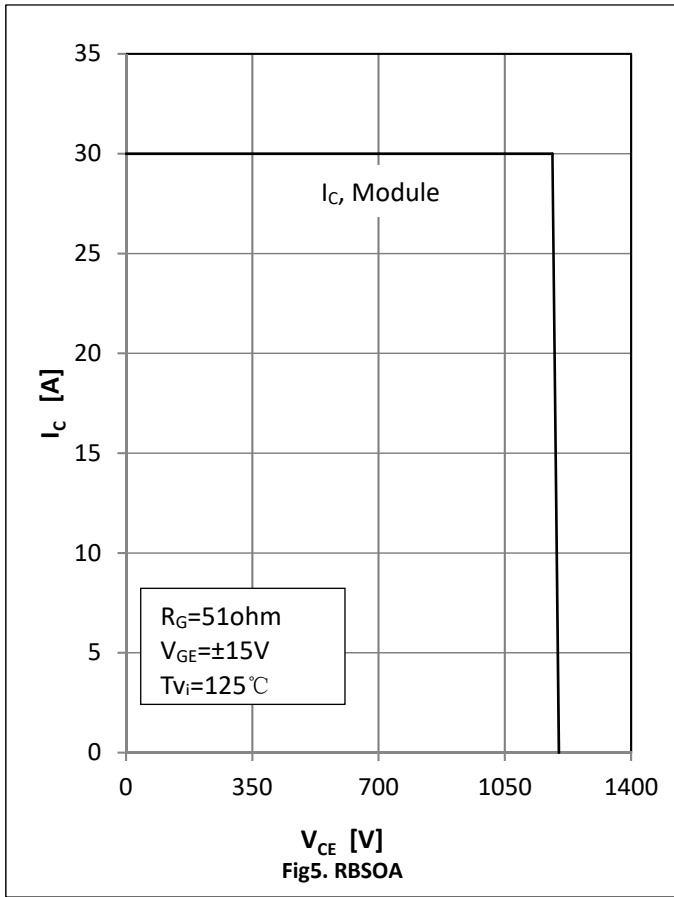

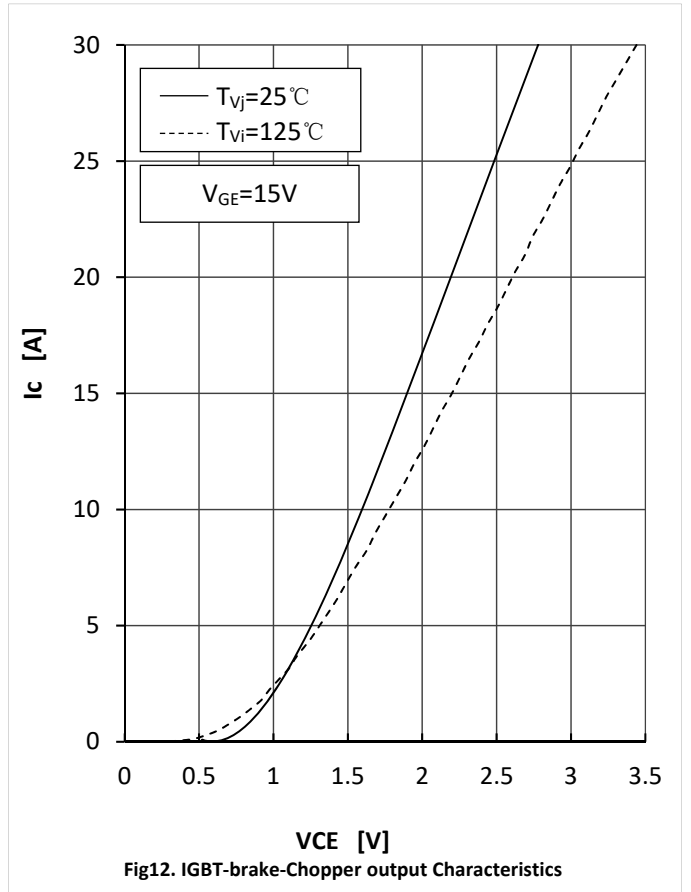
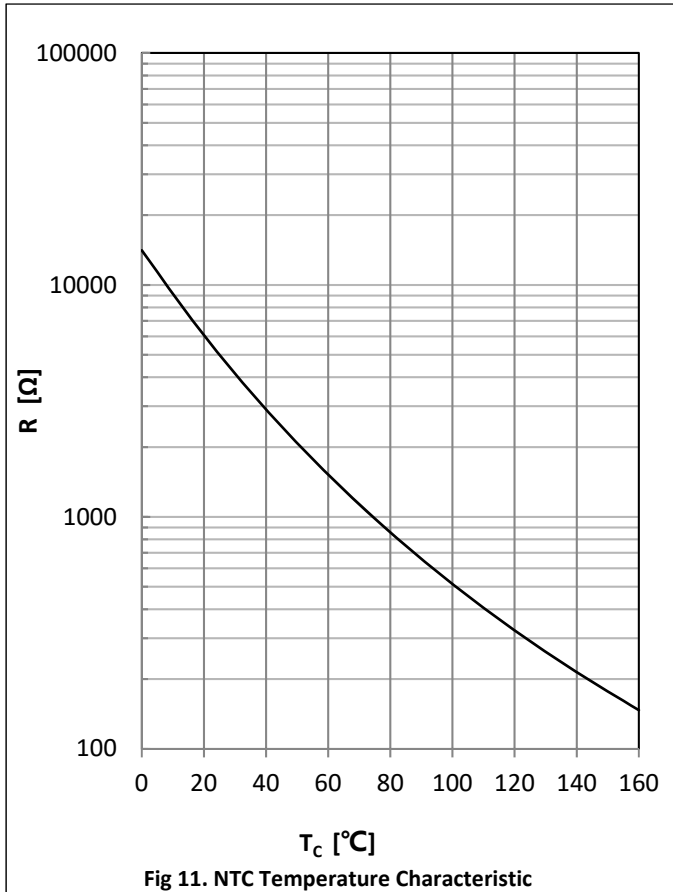
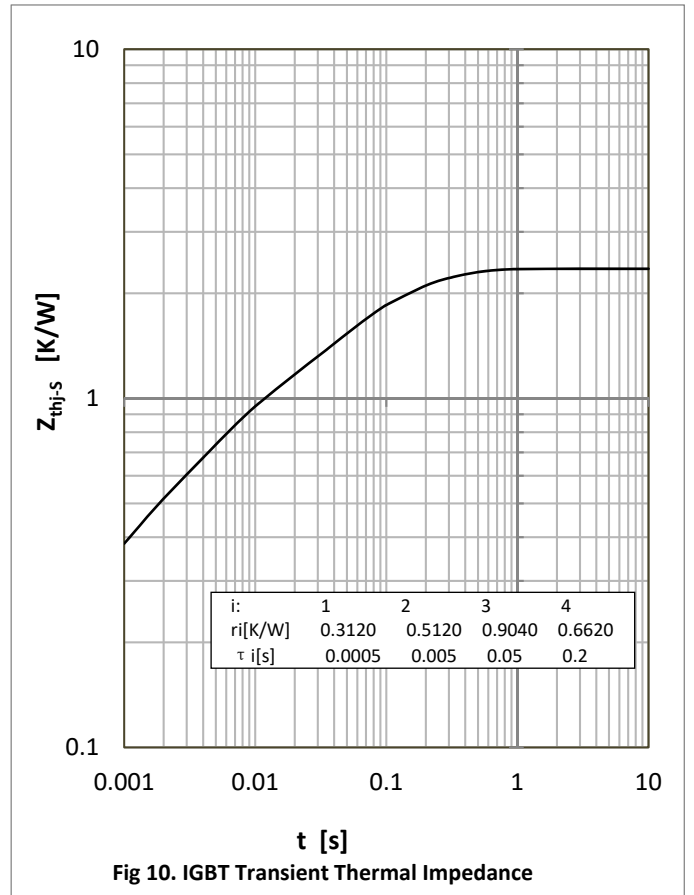
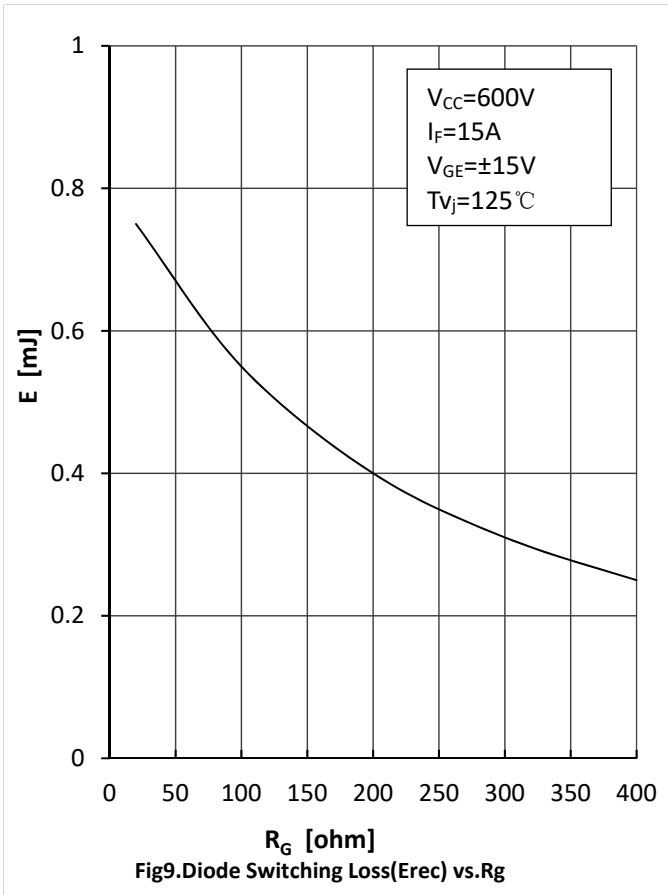

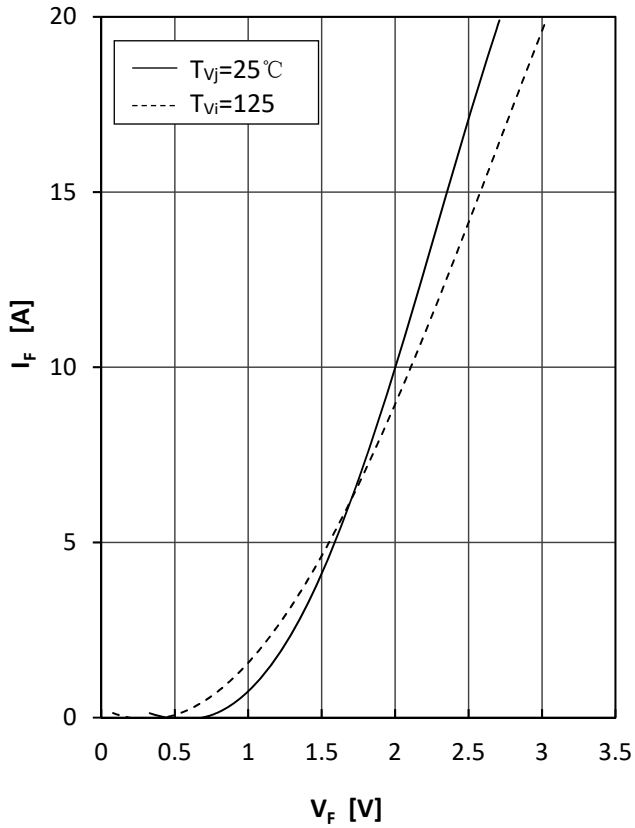
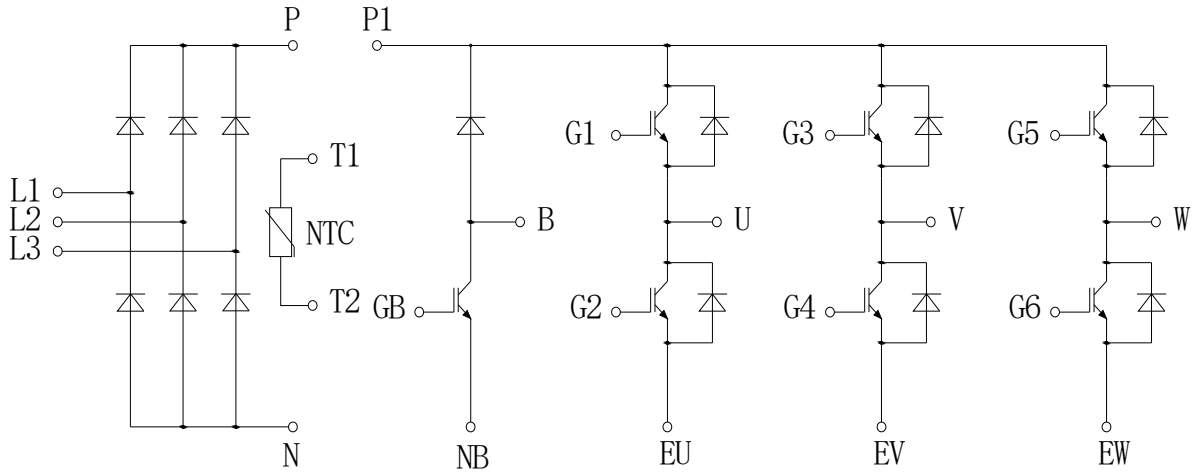

Fig13. Diode-brake-chopper Forward Characteristics



Circuit Diagram



Package Dimensions

